

# HPS12-36W

HPS12-36W is specially designed for high efficient discharge application. Its characteristics are high energy density, small footprint and high discharge efficiency. It can be used for more than 450 cycles at 50% discharge in cycle service, up to 5 years in float service.

## SPECIFICATIONS

Nominal Voltage	12 V
Number of cell	6
Nominal Capacity	36Wh/cell @ 15 min rate F.V.(1.67V/cell)
Approx. Weight	2.6Kg(5.73 lbs) (Weight deviation: $\pm 5\%$ )
Internal Resistance	$\leq 18m\Omega$ (Fully Charged, 25°C)
Max. Discharge Current	180 A (3 sec.)
Max. Charge Current	3.6 A
Operating Temperature Range	Charge : -10°C~50°C Discharge : -20°C~60°C Storage : -10°C~55°C
Nominal Operating Temperature Range	25 $\pm$ 5°C
Container Material	ABS(UL94-HB)&Flammability resistance of(UL94-V0) can be available upon request.
Self Discharge	3% of capacity declined per month at 20°C(average)
Charge Methods: Constant Voltage Charge (25°C)	
Cycle use	2.40-2.45VPC
Temperature compensation	-30mV/°C
Standby use	2.23-2.30VPC
Temperature compensation	-20mV/°C

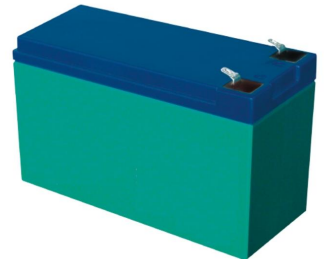

## Dimensions

	SI Units	English Units
Length	151mm	5.94inch
Width	65mm	2.56inch
Height	94mm	3.70inch
Total Height	100mm	3.94inch

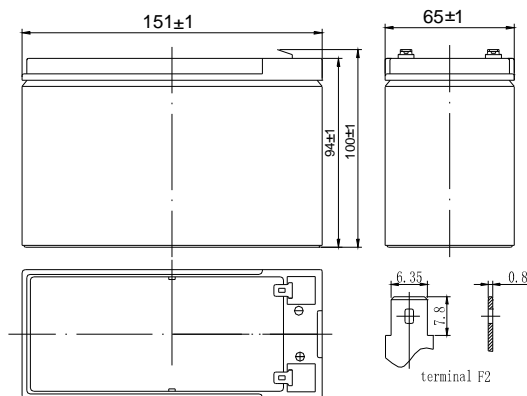

## Constant Current Discharge( Amperes at 25°C )

End Point Volts/cell	2 min	5 min	8 min	10 min	15 min	20 min	30 min	50 min	60 min
1.60	71.5	46.5	29.2	25.5	19.2	14.5	10.7	7.45	6.00
1.67	63.8	45.8	27.0	25.0	18.8	14.3	10.4	7.34	5.87
1.70	61.2	43.3	24.6	23.8	17.9	13.5	10.1	7.17	5.80
1.75	55.3	41.4	24.1	22.0	16.4	12.0	9.94	7.04	5.70
1.80	46.5	39.5	23.6	20.5	15.1	11.5	9.90	6.99	5.60

## Constant Power Discharge( Watts per Cell at 25°C )

End Point Volts/cell	2 min	5 min	8 min	10 min	15 min	20 min	30 min	50 min	60 min
1.60	115	85.2	49.0	46.0	37.2	28.0	20.7	14.6	11.9
1.67	104	82.3	47.5	45.5	36.0	27.6	20.2	14.4	11.8
1.70	101	78.3	46.5	44.8	34.5	26.0	19.8	14.2	11.5
1.75	94.5	75.4	42.4	40.1	31.3	22.4	19.5	14.0	11.3
1.80	86.4	72.4	41.2	39.8	28.5	21.8	19.0	13.8	11.0

(Note) The above characteristics data are average values obtained within three charge/discharge cycles not the minimum values. All data shall be changed without prior notice, VISION reserves the right to explain and update the information contained hereinto.

# HPS12-36W

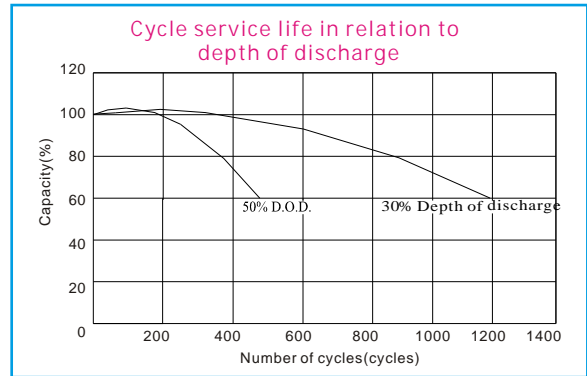
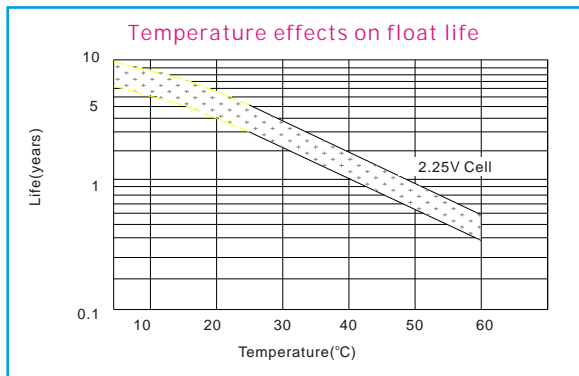
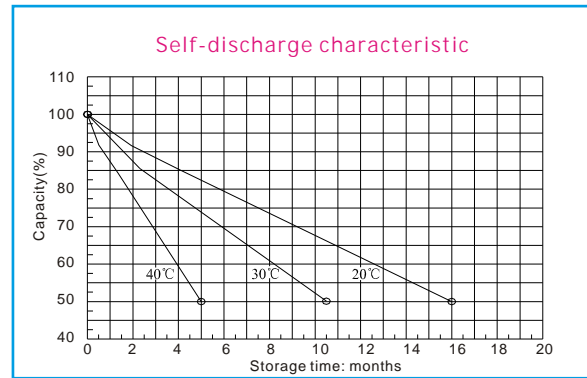
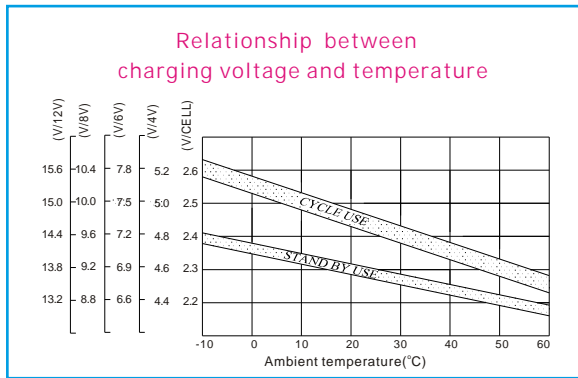
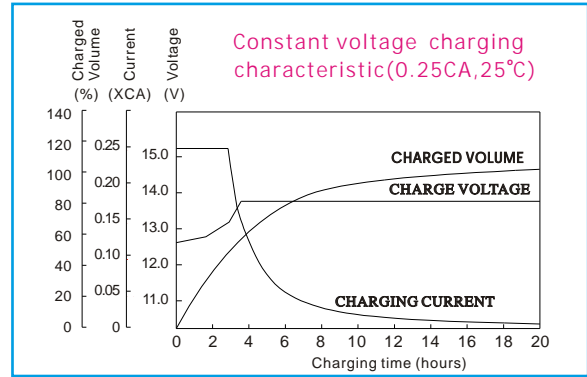
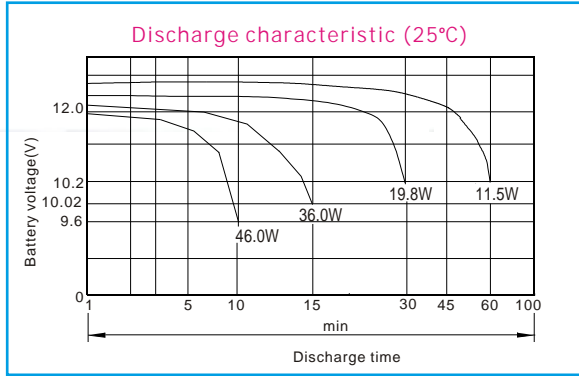

**Shenzhen Center Power Tech. Co., Ltd.**

Center Power Industrial Park, Tongfu Industrial District Dapeng Town, 518120 Shenzhen, China  
Tel: (+86-755) 8431 8088 Fax: (+86-755) 8431 8038 E-mail: sales@vision-batt.com



ISO9001:2000



MH25860



G4M19906-9202-E-16



[www.vision-batt.com](http://www.vision-batt.com)