

**RACK ASSEMBLY INSTRUCTIONS**

- READ ALL INSTRUCTIONS FULLY BEFORE ATTEMPTING TO INSTALL OR SET UP RACK.
- (A) CHECK RECEIVED PARTS AGAINST PARTS LIST BELOW.
- (B) RACK LOCATION SHOULD BE:
  1. AWAY FROM OUTSIDE SOURCES OF HEAT (DIRECT SUN-LIGHT, RADIATORS, STEAM PIPES ETC.)
  2. ON LEVEL GROUND.
  3. EASILY ACCESSIBLE FOR CELL READINGS AND WATER ADDITIONS, IF APPLICABLE (PL BATTERIES).
- (C) MARK LOCATION ON FLOOR AND POSITION FRAMES.
- (D) INSTALL BRACES ON TO FRAMES AND HAND TIGHTEN NUTS.
- (E) INSTALL RAILS IN APPROPRIATE POSITION FOR BATTERY SYSTEM TO BE USED AND HAND TIGHTEN NUTS.
- (F) CHECK THAT RAILS AND BRACES ARE IN CORRECT POSITION AND SQUARE RAIL WITH FRAME.
- (G) INSTALL RAIL INSULATION ON BOTH INSIDE SURFACES OF THE RAIL MAKING SURE THEY MEET AT THE BEND IN THE RAIL.
- (H) TIGHTEN ALL NUTS TO A 30 FT/LB TORQUE VALUE STARTING WITH BRACES FIRST, THEN RAILS.
- (I) \*BOLT FRAMES TO FLOOR. FOR UBC 97 ZONE FOUR CERTIFIED RACKS, A MINIMUM OF 6" OF SPACING IS NEEDED AROUND ALL SIDES OF RACK.
- (J) USE MOUNTING HOLES #3 & 4 FOR PL-7, PL-8, PL-10, PL-11, PL-15 & PL-27 BATTERIES WHEN INSTALLING CELLS LENGTHWISE. OTHER MOUNTING HOLES MAY BE USED FOR OTHER ARRANGEMENTS WHEN SMALLER LENGTHS OF RACKS ARE REQUIRED.
- (K) ALL MOUNTING SLOTS ARE 1/2" X 1" AND SUPPLIED WITH 3/8" HARDWARE KIT.
- (L) ALL RACKS ARE MADE OF STEEL ANGLE SUPPORTS AND ARE PAINTED WITH A TEXTURED IBM WHITE ELECTROSTATIC POWDER COAT.

NOTE: A MINIMUM OF 6" OF SPACE IS NEEDED AROUND EACH SIDE OF RACK IN ORDER TO MEET UBC 97 SEISMIC CRITERIA.

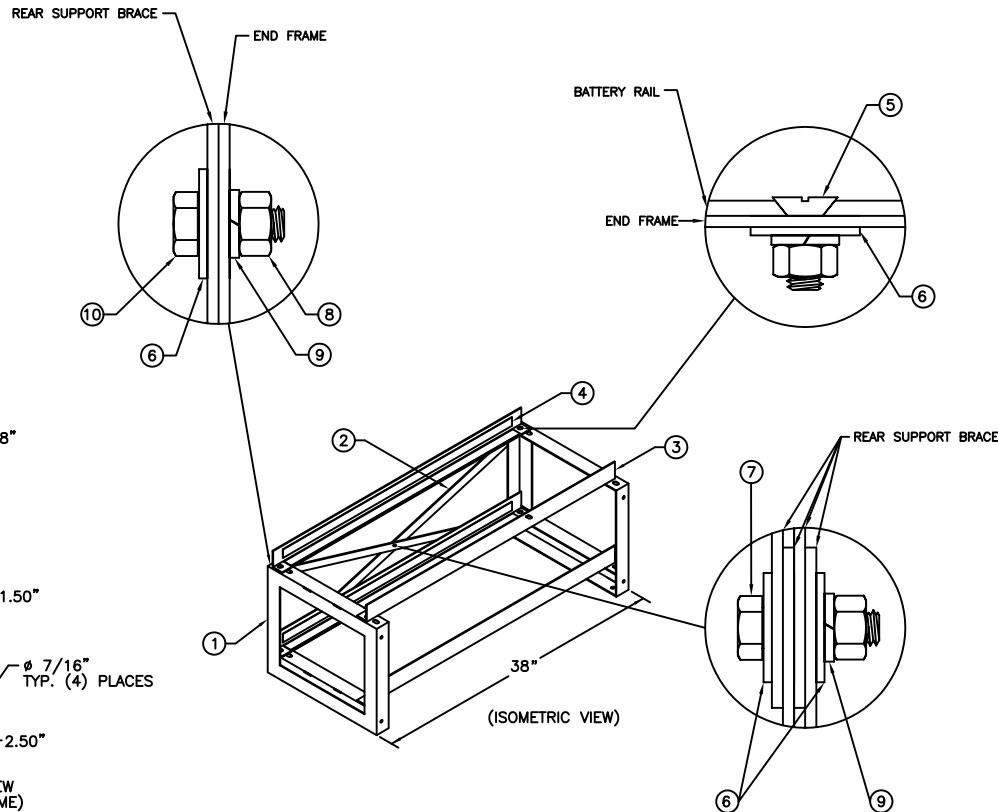
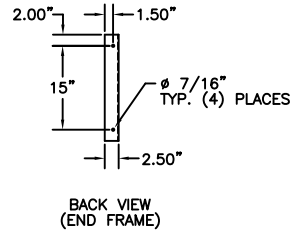
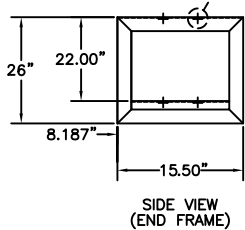
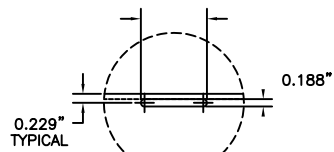
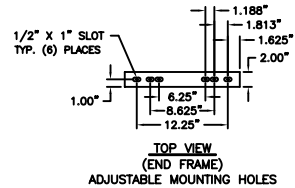
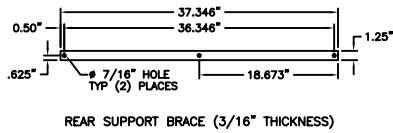
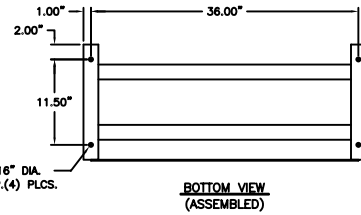
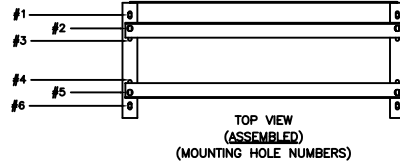
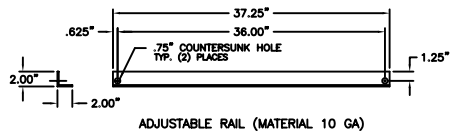

SEISMIC ZONE	*ANCHORING COMPONENTS	SEISMIC SUPPORT BEAMS
1	4-#1/2"x6" ROD WITH E12 EPOXY CAPSULES	NOT REQUIRED
2A	4-#1/2"x6" ROD WITH E12 EPOXY CAPSULES	NOT REQUIRED
2B	4-#1/2"x6" ROD WITH E12 EPOXY CAPSULES	NOT REQUIRED
3	4-#1/2"x6" ROD WITH E12 EPOXY CAPSULES	NOT REQUIRED
4	4-#1/2"x6" ROD WITH E12 EPOXY CAPSULES	NOT REQUIRED

\*SEE ANCHORING INSTRUCTION DRAWING ANC-9001.

HARDWARE KIT: HK-0005		
10	3/8" FLAT WASHER	10
9	3/8" SPLIT LOCK WASHER	9
8	3/8" HEX NUT	9
7	3/8" X 1 1/2" HEX HEAD SCREW	1
6	3/8" X 1 1/4" HEX HEAD SCREW	4
5	3/8" X 1" COUNTERSUNK FLAT HEAD SCREW	4
NO.:	DESCRIPTION:	QTY.:

4	BATTERY RAIL INSULATION KIT	1	RB38-BRI
3	ADJUSTABLE BATTERY RAILS	2	RB38-ABR
2	REAR SUPPORT BRACE	2	RB38-B
1	END FRAME	2	RB38-RF
NO.:	DESCRIPTION:	QTY.:	PART NO.:

REVISIONS		DATE:
NO.	DATE	BY
E		
F		
G		
H		
I		
J		

03/16/11

SCALE: NONE

DRAWN BY: Luis

NOT VALID UNLESS APPROVED BY:

DRAWING NO.:



BR38S ASSEMBLY DRAWING ONE TIER  
SEISMIC ZONE 1-4 CERTIFIED BATTERY RACK

RB38S